

➤ Instructions

Thule Yepp Nexxt 2 Maxi Frame Mount

12080251, 12080252, 12080253, 12080254,
12080255, 12080256

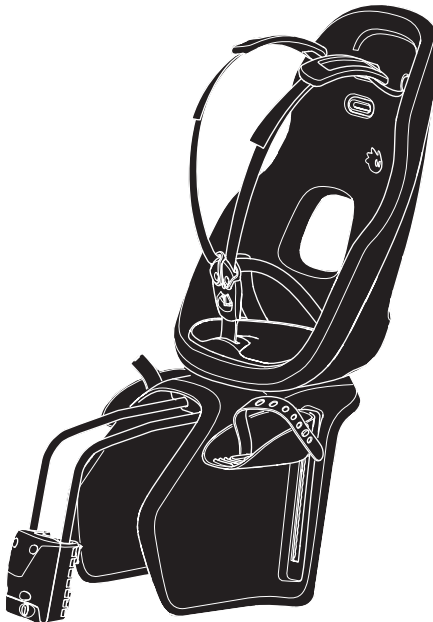

EN Rear mounted child bike seat
FR Siège vélo enfant arrière
ES Asiento para niños en la parte trasera de la bicicleta
DE Fahrradkindersitz
NL Fietszitje voor achterop
PT Assento infantil traseiro para bicicleta
IT Seggiolino da bicicletta posteriore
SV Cykelbarnstol för bakre cykelmontering
DK Bagmonteret cykelstol
NO Bakmontert barnesykkelse
FI Lastenistuun polkupyörän taakse
IS Barnasæti aftan á reiðhjól
ET Jalgratta tagumine lasteiste
LV Velosipēda aizmugurējais bērna sēdekļis
LT Galinė vaikiška dviračio kėdutė
RU Заднее детское велосипедное сиденье
UK Заднє дитяче велосипедне крісло
PL Fotelik rowerowy do przewożenia dziecka montowany z tyłu

CS Zadní dětská cyklosedačka
HU Kerékpáros hátsó gyerekülés
RO Scaun spate de copii pentru bicicletă
SK Zadná detská cyklosedačka
SL Zadnji otroški kolesarski sedež
BG Задна детска седалка за велосипед
HR Dječja sjedalica za bicikl koja se postavlja straga
EL Πίσω παιδικό κάθισμα ποδηλάτου
TR Arkaya Bağlanan Çocuk Bisiklet Koltuğu
MT Sedil tar-Rota għat-Tfal li Jitpoġġa Wara

מושב אופניים אחורי לילד **HE**
مقعد الدراجة الخلفي للطفل **AR**

ZH (CN) 后置式儿童自行车座椅
ZH (TW) 後座式自行車兒童座椅
JA サイクル後部用チャイルドシート
KO 후면 어린이 자전거 시트
TH เก้าอี้เด็กสำหรับซ้อนท้ายจักรยาน
MS Tempat Duduk Basikal Kanak-kanak Belakang

EN 14344:2022

ASTM F1625-00



- EN** Please read the following instructions carefully and keep them for future reference.
- DE** Bitte die folgenden Anleitung aufmerksam durch und bewahren Sie sie zum späteren Nachschlagen auf.
- FR** Veuillez lire attentivement les instructions suivantes et les conserver pour référence future.
- NL** Dient u zorgvuldig de volgende instructies te lezen en deze als toekomstig naslagwerk te bewaren.
- IT** Leggi le seguenti istruzioni attentamente e conservale per consultazioni future.
- ES** Lea las instrucciones siguientes atentamente y guárdelas para consultas posteriores.
- PT** Leia cuidadosamente as instruções a seguir e guarde-as para referência futura.
- SV** Vi ber dig läsa följande instruktioner noggrant och därefter behålla dem för framtida bruk.
- DK** Skal du læse følgende anvisninger grundigt igennem og gemme dem til fremtidig reference.
- NO** Bør du lese disse instruksjonene nøye. Ta vare på dem i tilfelle du får bruk for dem senere.
- FI** Lue seuraavat ohjeet huolellisesti. Pidä ohjeet tallessa.
- IS** Lestu þessar leiðbeiningar vandlega áður en þú og geymdu þær til síðari nota.
- ET** kasutuselevõttu lugege järgmised juhised hoolikalt läbi ja hoidke need alles.
- LV** lūdzu, izlasiet uzmanīgi tālāk sniegtos norādījumus un saglabājiet tos turpmākai izmantošanai.
- LT** atidžiai perskaitykite toliau pateiktas instrukcijas ir jų neišmeskite, kad galėtumėte peržiūrėti ateityje.
- PL** należy dokładnie przeczytać następujące instrukcje i zachować je do wykorzystania w przyszłości.
- RU** внимательно изучите представленные ниже инструкции и сохраните их для дальнейшего использования.
- UK** ознайомтеся з нижченаведеними інструкціями й зберігайте їх для довідки в майбутньому.
- BG** прочетете внимателно следните инструкции и ги запазете за бъдещи справки.
- CS** si pečlivě přečtěte následující pokyny a uložte si je, abyste se k nim mohli kdykoli vrátit.
- SK** si pozorne prečítajte nasledujúce pokyny a uložte si ich, aby ste sa k nim mohli kedykoľvek vrátiť.
- SL** skrbno preberite navodila v nadaljevanju in jih shranite.
- HR** pažljivo pročitajte sljedeće upute i sačuvajte ih za buduću uporabu.
- RO** citiți cu atenție următoarele instrucțiuni și păstrați-le pentru consultare ulterioară.
- HU** használatbavétele előtt figyelmesen olvassa el az alábbi tudnivalókat, és tartsa azokat később is hozzáférhető helyen
- EL** διαβάστε προσεκτικά τις παρακάτω οδηγίες και φυλάξτε τις για μελλοντική αναφορά.
- TR** kullanmadan önce aşağıdaki talimatları dikkatle okuyun ve gelecekte başvurmak amacıyla saklayın.
- MT** jekk joghħbok aqra l-istruzzjonijiet li ġejjin bir-reqqa u żommmhom għal referenza futura.
- HE** קרא את ההוראות להלן בקפידה ושומר עליהן לעיון במועד מאוחר יותר.
- AR** يرجى قراءة التعليمات التالية بعناية والاحتفاظ بها للرجوع إليها في المستقبل.
- ZH (CN)** 请仔细阅读以下说明,并保留该说明以供日后参考。
- JA (TW)** 請詳閱以下說明,並妥善保管以便未來參考使用。
- JA** をご利用になる前に、以下の手順を最後までお読みいただき、今後も参照できるように保管してください。
- KO** 을 사용하기 전에 다음 지침을 잘 읽고 나중에 참고할 수 있도록 보관해 주십시오.
- TH** โปรดอ่านคำแนะนำต่อไปนี้อย่างละเอียดและเก็บไว้เพื่อใช้อ้างอิงในอนาคต
- MS** sila baca arahan berikut dengan teliti dan simpan arahan ini untuk rujukan masa hadapan.

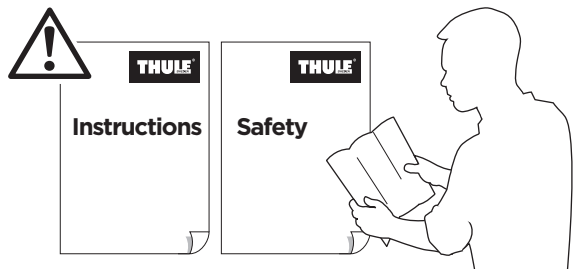

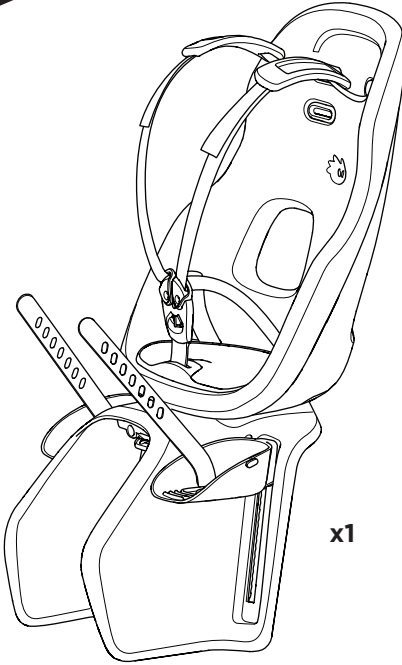

x1

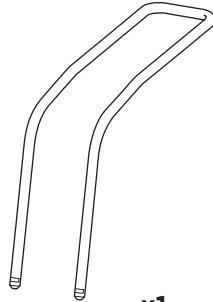

x1



x1



x1



x1



x2

 **x4**
M6x44
M6x1.7 inch

 **x4**
M6x58
M6x2.3 inch



9-72 M	9-72 M
9-22 kg	20-40 lbs
110 cm	43.3 inch



Your Key-Number



0-9 M



Circular



Ø 28-40 mm
Ø 1,10-1,57 inch

Oval



Max 40 mm
Max 1,57 inch



Triangular



Square



May cause frame damage

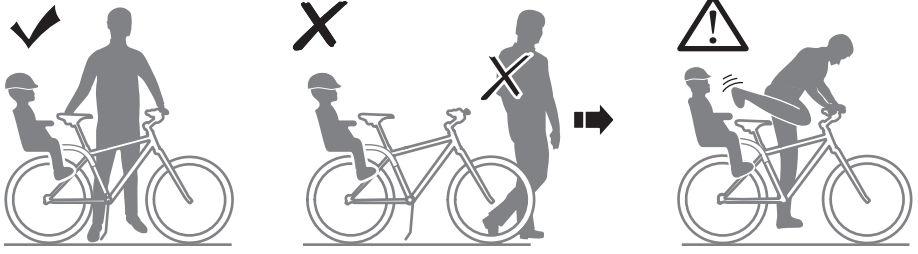

Max. 25 km/h
15 mph

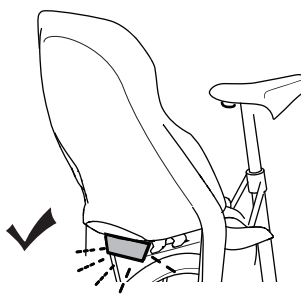
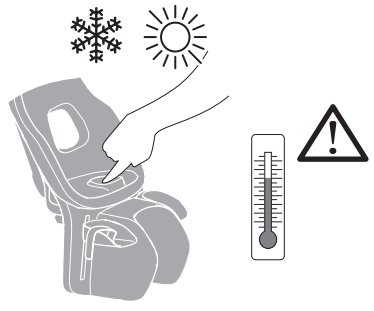
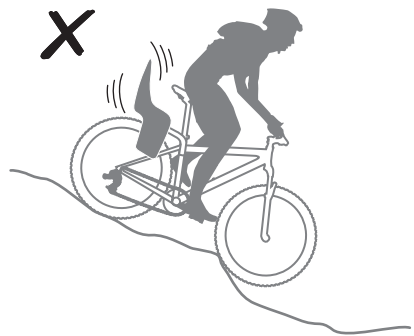
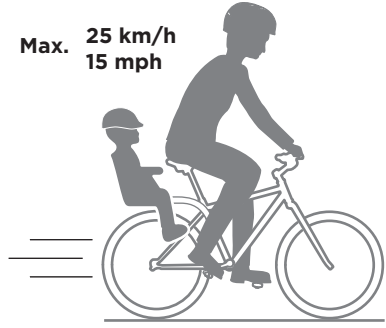

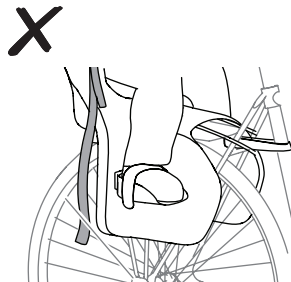
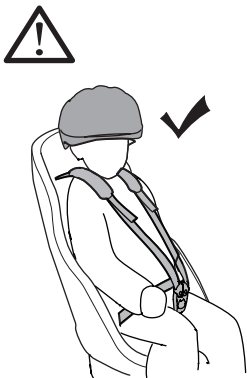
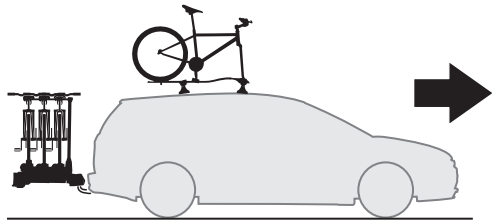
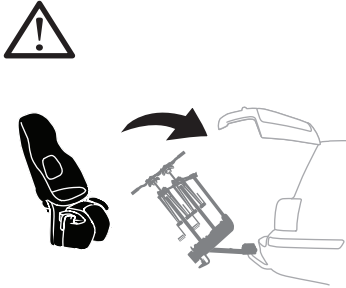
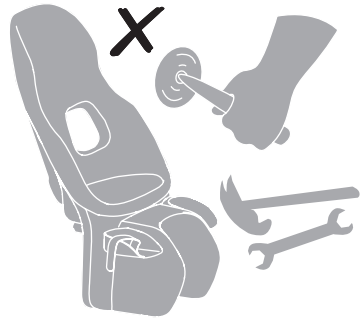
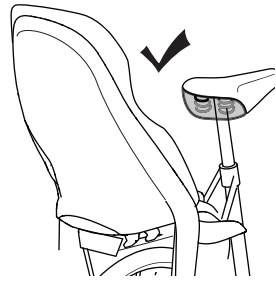
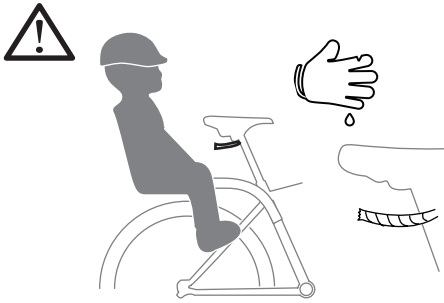

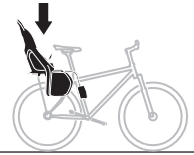

1

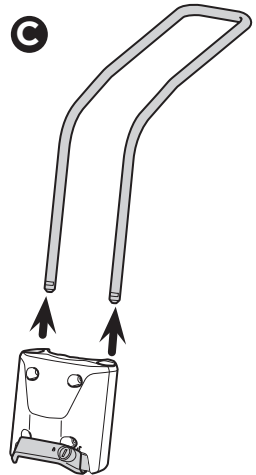
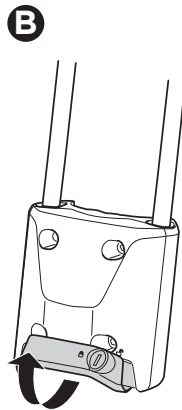
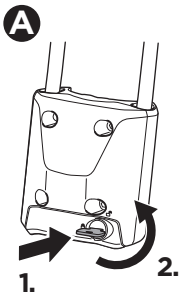
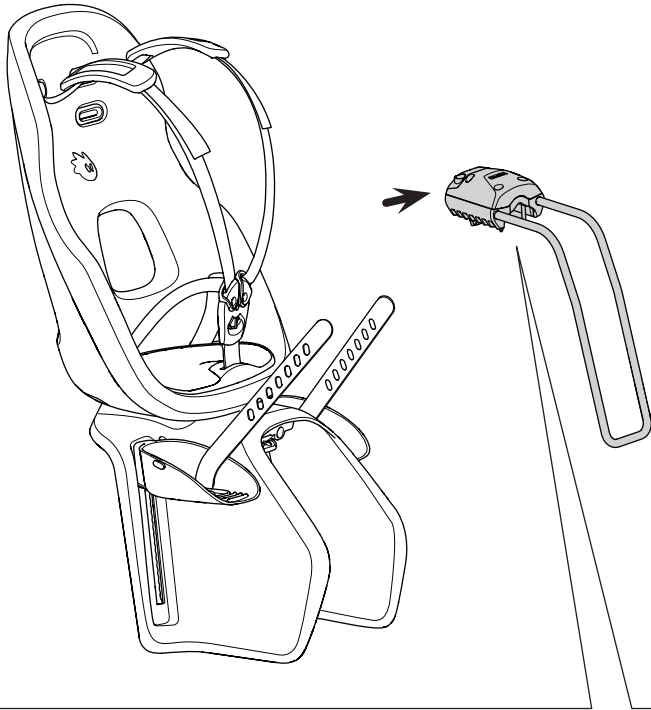

2

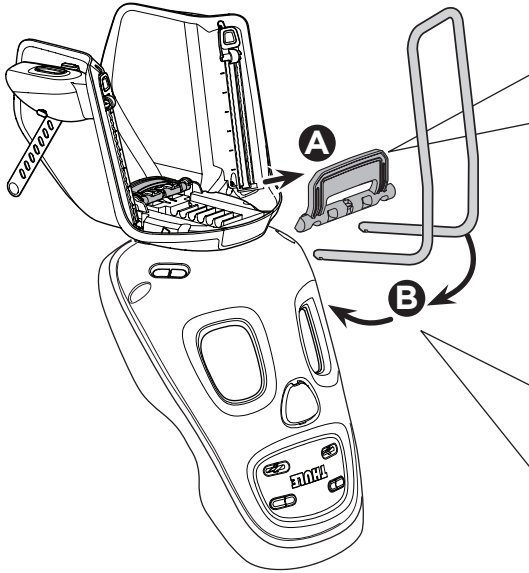

A

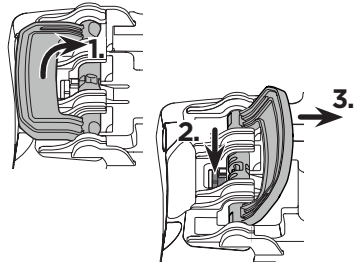

B

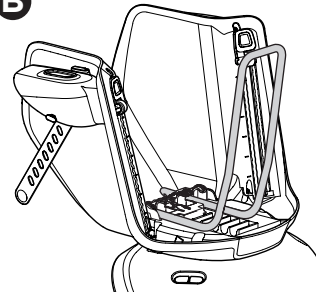

3

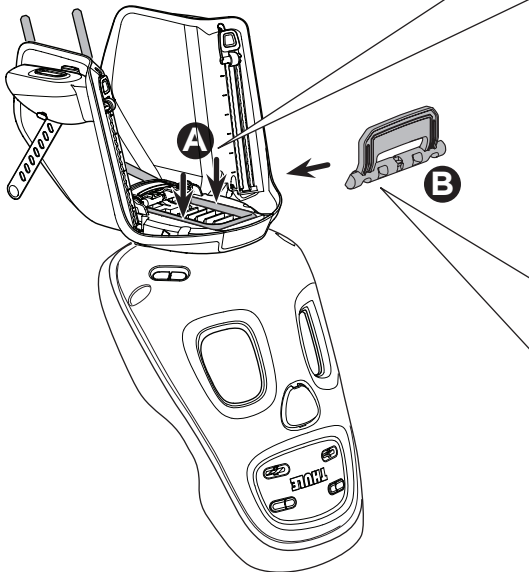

A

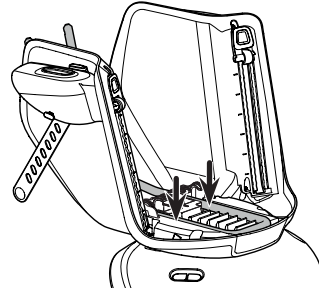

B

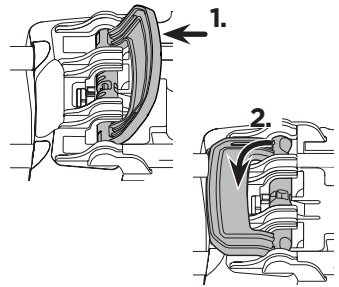

4

Ø 28-40 mm
Ø 1.10-1.57 inch

40x55 mm
1.57-2.16 inch

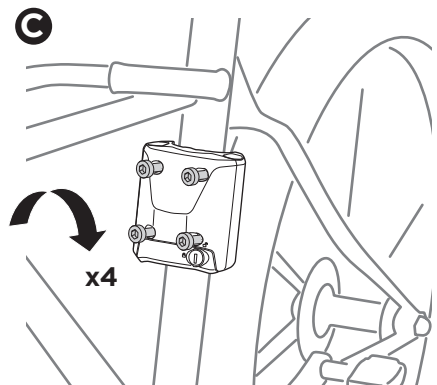
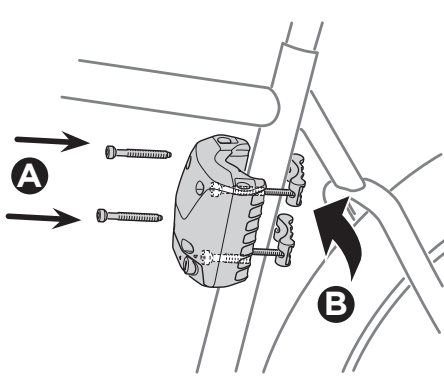
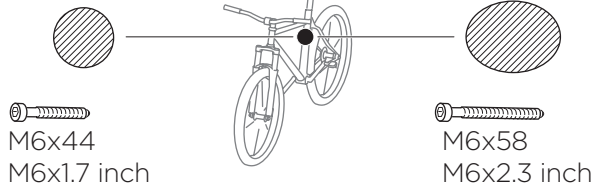

5

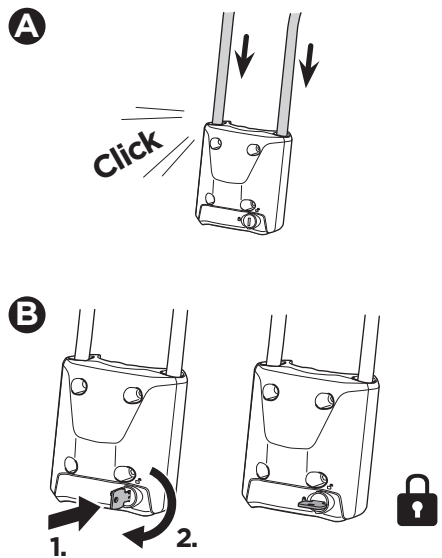
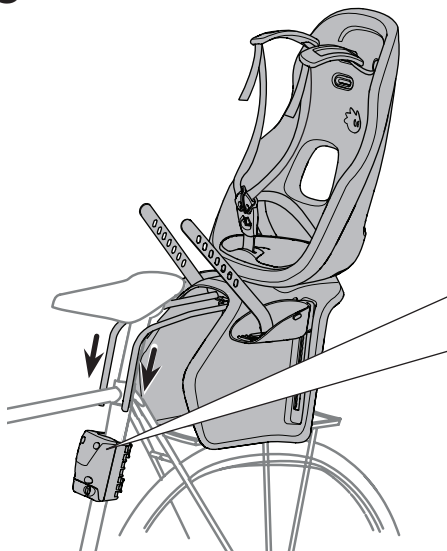

6

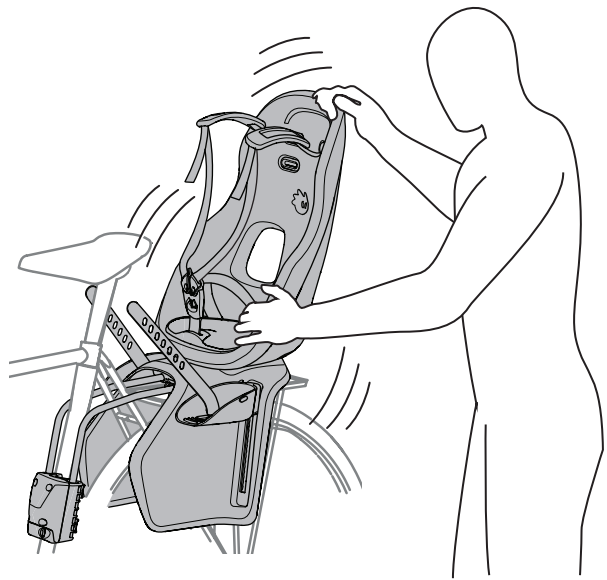
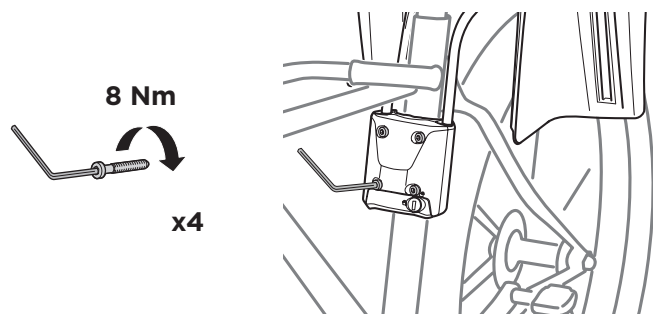
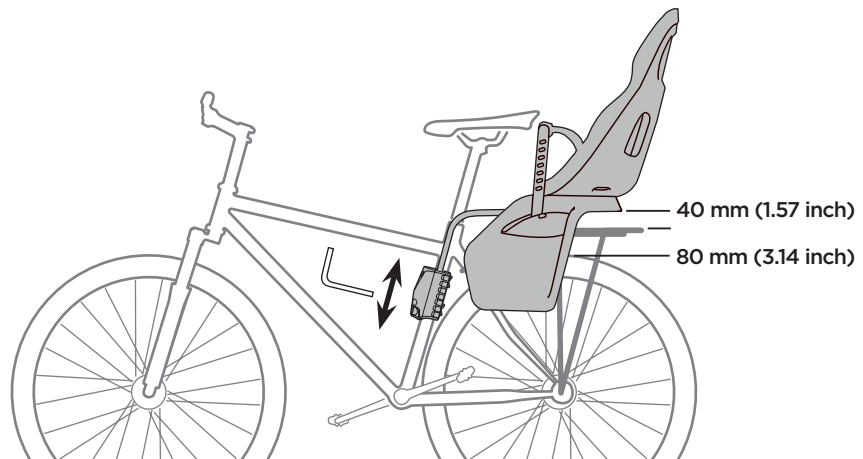

7

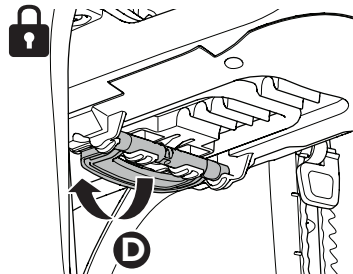
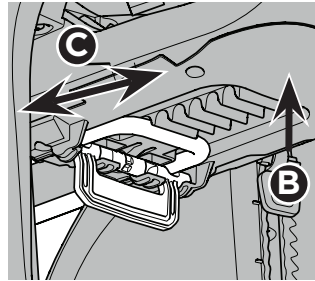
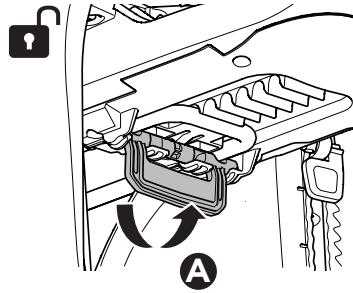
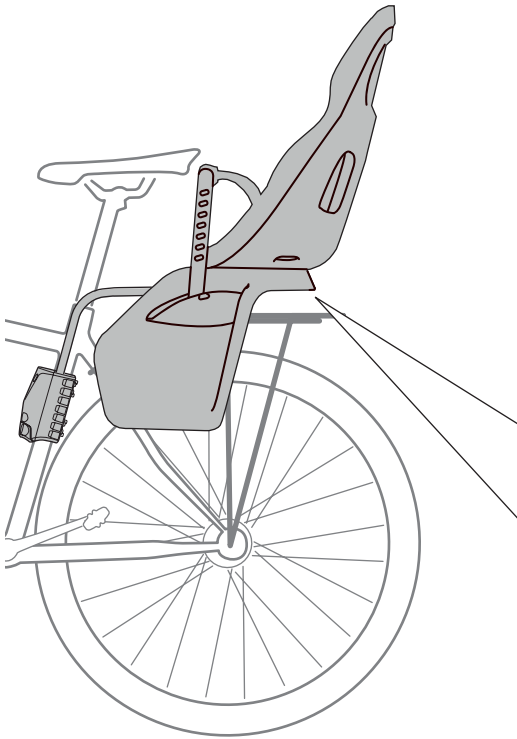
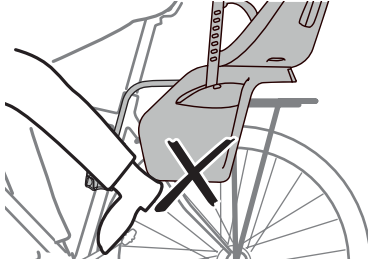



1

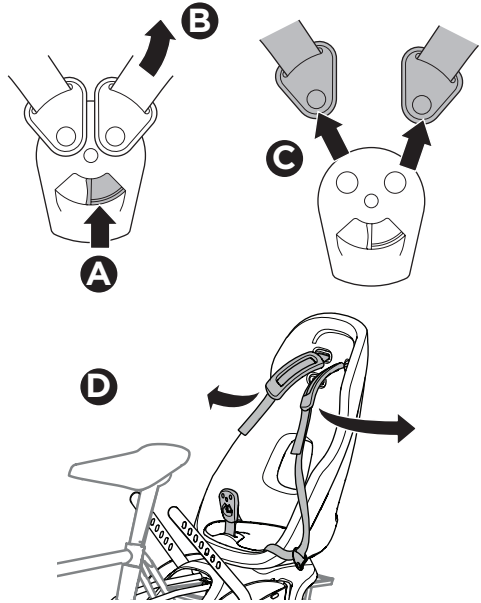
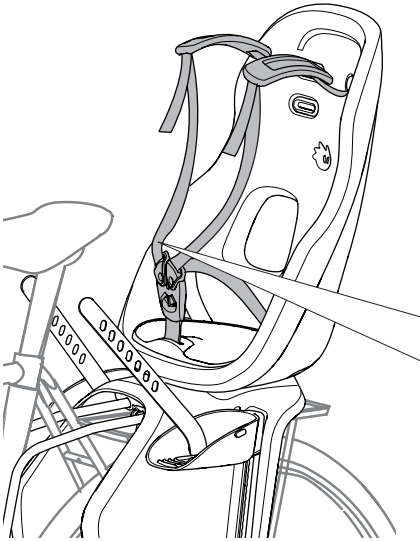

2

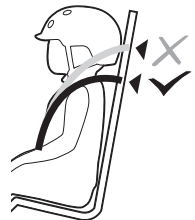
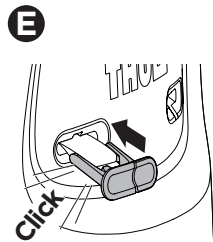
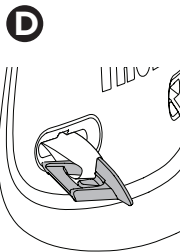
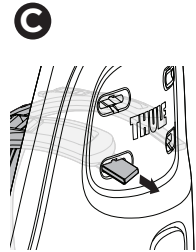
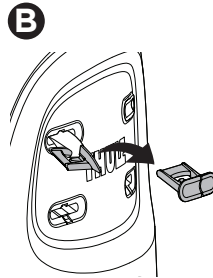
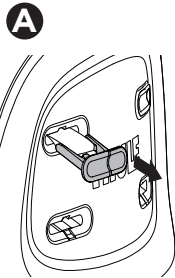
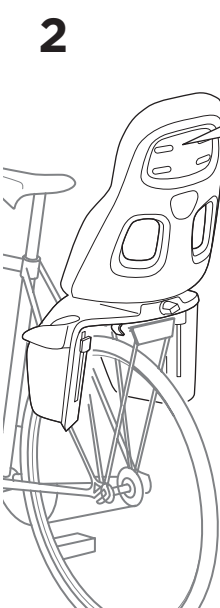

3

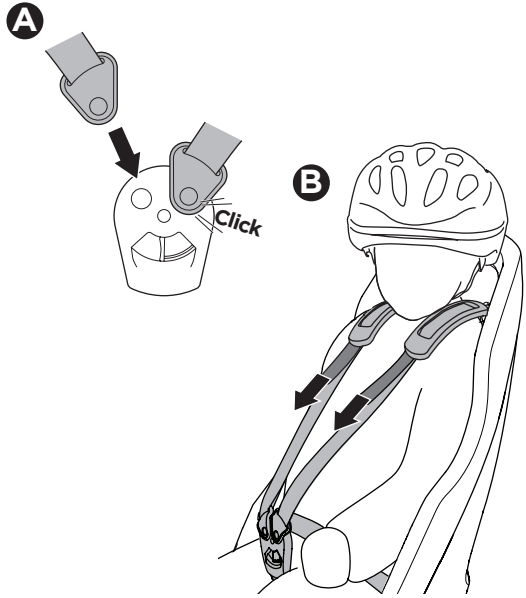
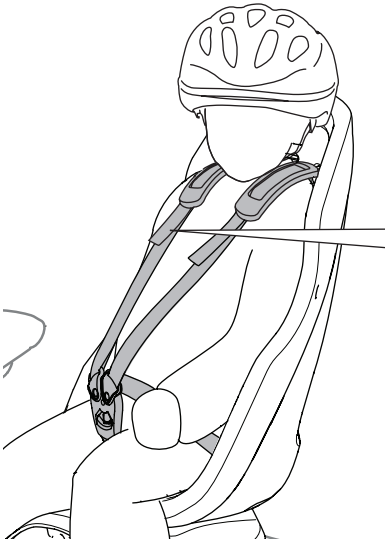

4

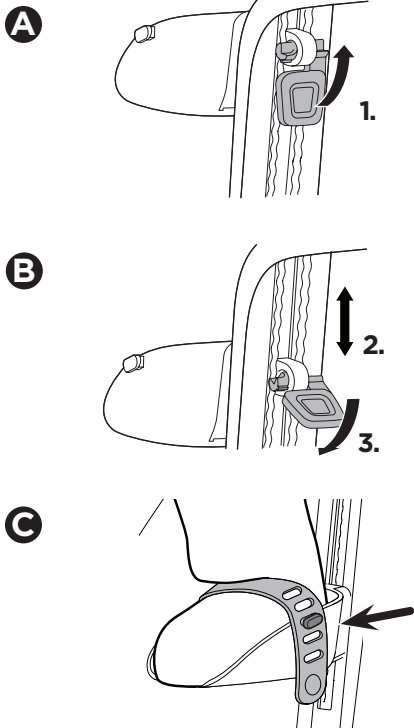
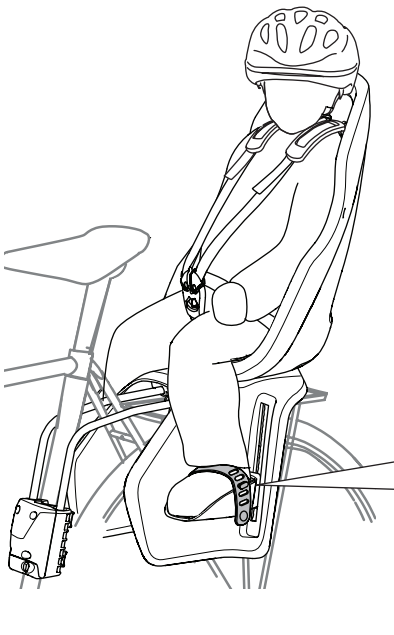

i

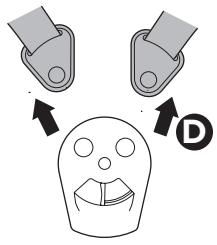
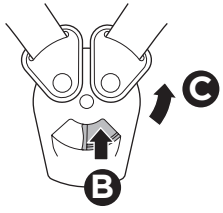
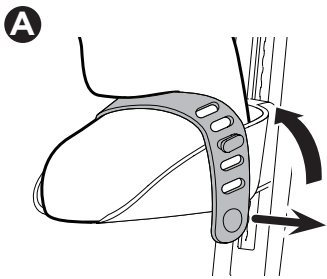
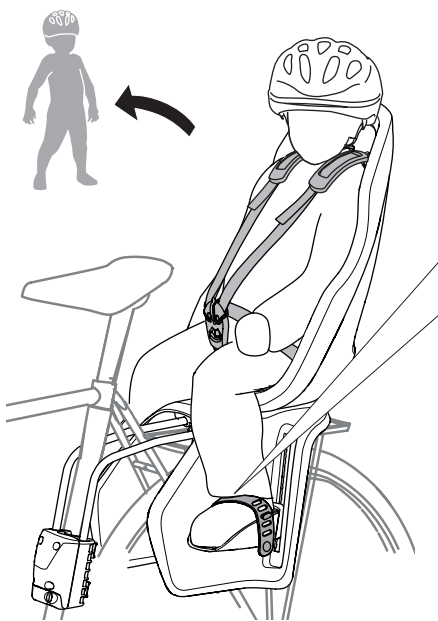

E

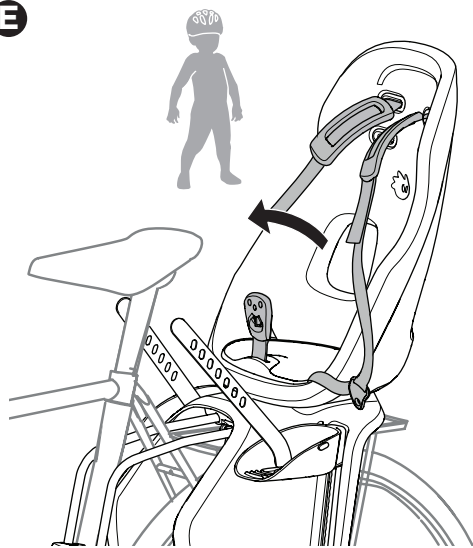

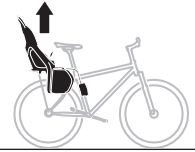

A

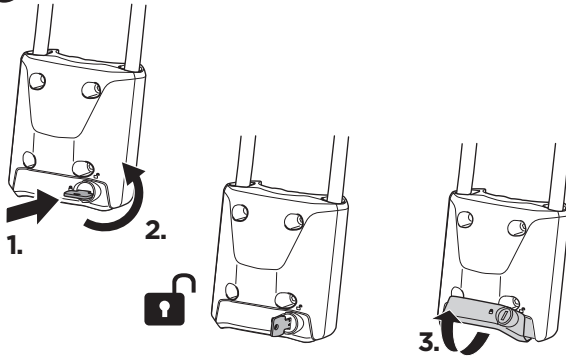

B

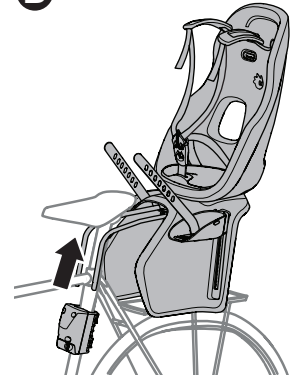

EN Accessories
FR Accessoires
ES Accesorios
DE Zubehör
NL Accessoires
PT Acessórios
IT Accessori
SV Tillbehör
DK Tilbehør
NO Tilbehør
FI Lisävarusteet
IS Aukabúnaður

ET Tarvikud
LV Piederumi
LT Priedai
RU Аксессуары
UK Акcesyari
PL Akcesoria
CS Příslušenství
HU Kiegészítők
RO Accesorii
SK Príslušenstvo
SL Dodatna oprema
BG Аксесоари

HR Dodatna oprema
EL Αξεσουάρια
TR Aksesuarlar
MT Accessorji

אביזרים HE
الملحقات AR

ZH (CN) 附件
ZH (TW) 配件
JA アクセサリー
KO 액세서리
TH อุปกรณ์เสริม
MS Aksesori

Thule Yepp Raincover 12020972



Thule Quick Release Bracket 100203



Thule Delight 20201516

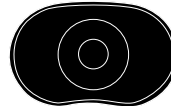

Thule Yepp Harness Clip 12020920

